

ASSEMBLY INSTRUCTION

Caution



Keep children and pets away from the electric height-adjustable desk during the operation. Unplug the power cord during a thunderstorm or if you do not intend to use the desk for a long time.



Make sure desktop not touching the wall.



Ensure no obstacles in the desk's path and no object above and 20" under the desk.



Working environment temperature 0-40°C, keep products away from corrosive gas, liquid and dusty objects.



It is strictly forbidden to disassemble the products privately to avoid that the failure of the products or the damage to the human body caused by electronic products, etc.



Although the product with anti-collision function, in order to avoid any pinching, please ensures that hands or other parts of your body are in a safe position during the operation. Anti-collision is not enabled during all resets.



Please read the following instructions carefully before start using the high-adjustable desk. The company does not bear any warranty or liability for damage and human injury caused by any abnormal operation.



It is necessary to reset manually after the initial installation or power off.

Parts List

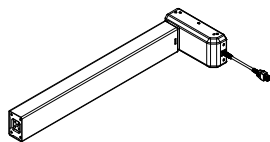

A - Column x 2

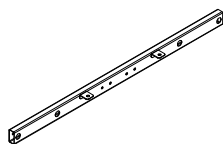

B - Connection Tube x 2

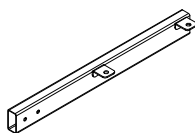

C - Supporting Tube

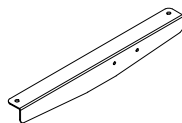

D - Left Side Bracket

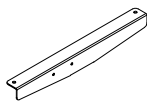

E - Right Side Bracket

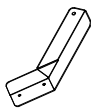

F - Bending Left Side Bracket

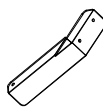

G - Bending Right Side Bracket

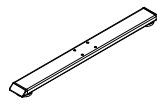

H - Foot x 2

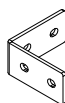

I - L Connector x 2

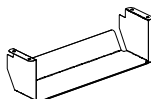

J - Bracket

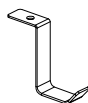

K - Hook x 2

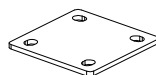

L - Connecting Board x 6



M - Universal Wheel
x 4



N - Wrench



O - Control Box

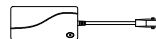

P - Power Supply

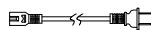

Q - Power Cord



R - Extension Cable x 2



S - Cable clip
x 8



T - ST4.8x13 screw
x 44



U - ST2.9x15 screw
x 2



V - M6x10 Screw
x 20



W - M6x30 Screw
x 8



X - Wooden pin
x 8



Y - M5 Allen Key

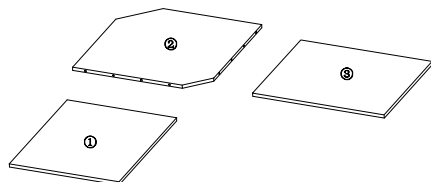

Z - Table board 1/2/3

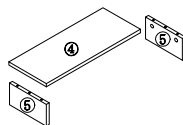

I - The table bench

Tools Needed (Not Included)

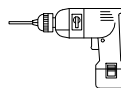

Electric Drill

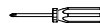

Phillips Screwdriver

Assembly

Step 1

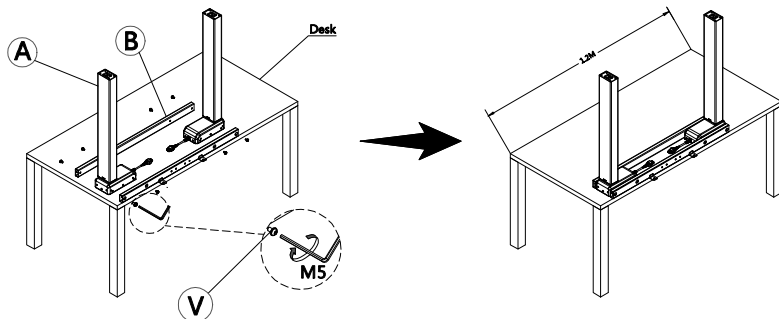

Checklist

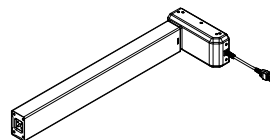

A - Column x 2

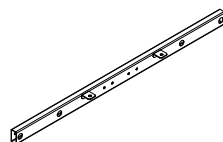

B - Connection Tube x 2



Y-M5



V - M6x10
Screw x 8

Step 2

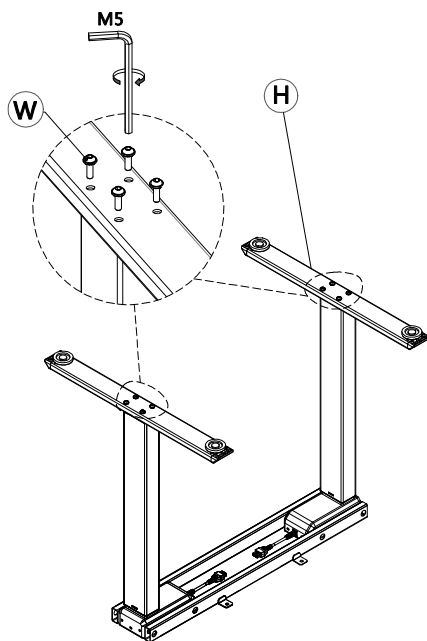

Checklist

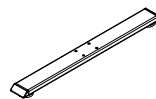

H - Foot x 2



Y-M5



W - M6x30 Screw
x 8



Assembly

Step 3

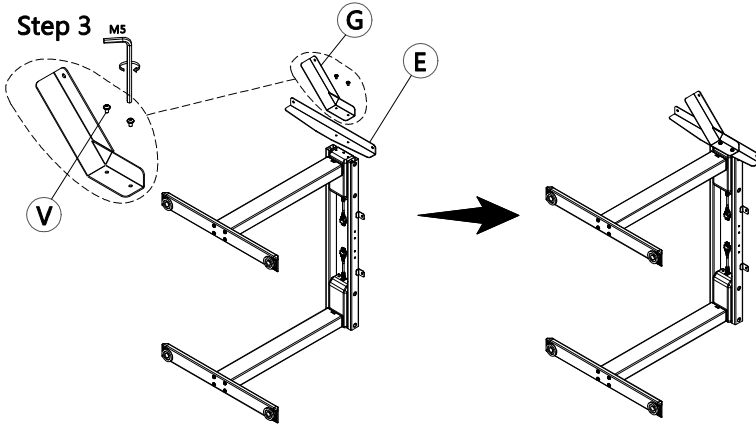

Checklist

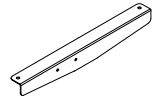

E - Right Side Bracket

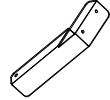

G - Bending Right Side Bracket



M5



V - M6x10 Screw x 2

Step 4

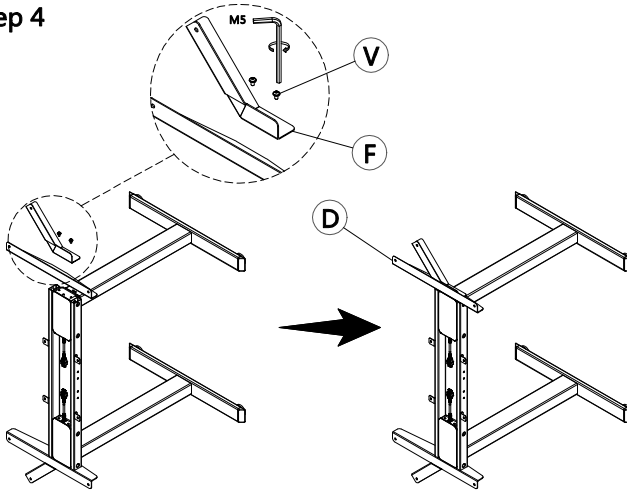

Checklist

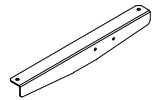

D - Left Side Bracket

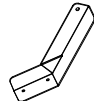

F - Bending Left Side Bracket



M5



V - M6x10 Screw x 2

Step 5

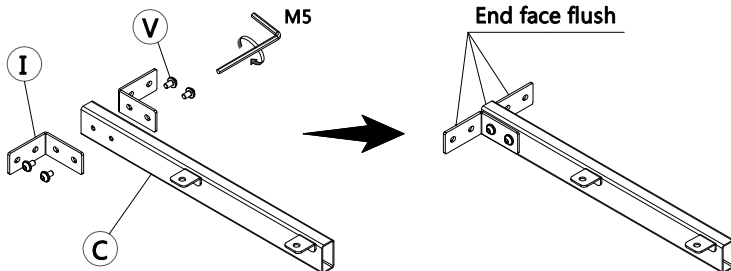

Checklist

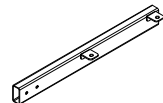

C - Supporting Tube



V - M6x10 Screw x 4



I - L Connector x 2



M5

Step 6

Checklist



V - M6x10
Screw x 4



M5

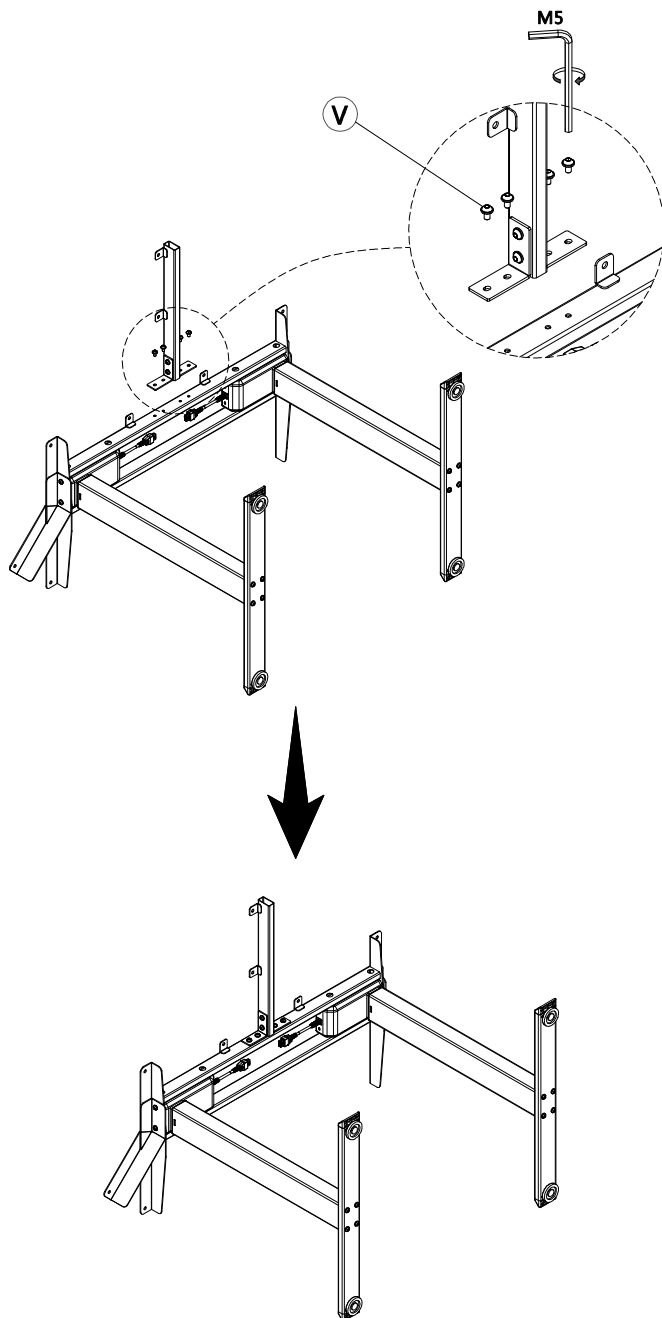

Step 7

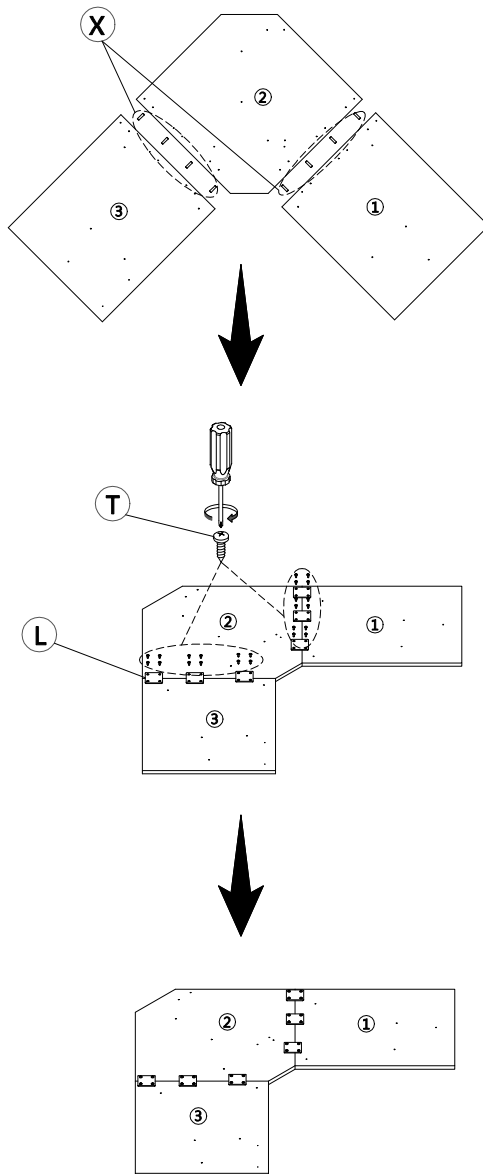

Checklist

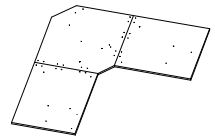

Z - Table board 1/2/3



X - Wooden pin x 8



T - ST4.8x13 screw
x 24



L - Connecting board x 6



Avoid excessive tightening screws

Step 8

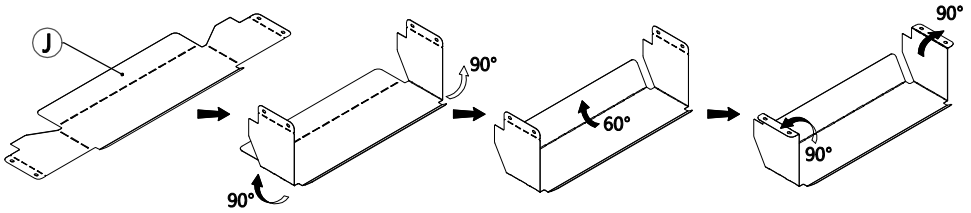

Step 9

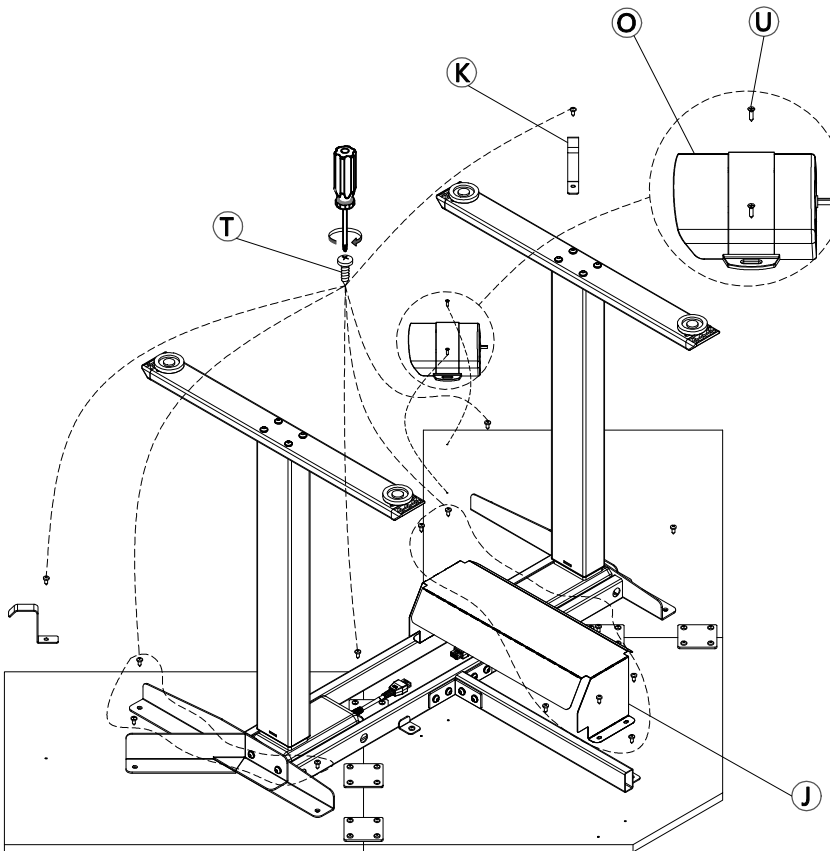

Checklist

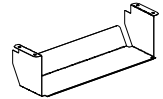

J - Bracket



K - Hook x 2



O - Control Box



T - ST4.8x13 screw x 18



U - ST2.9x15 screw x 2



Avoid excessive tightening screws

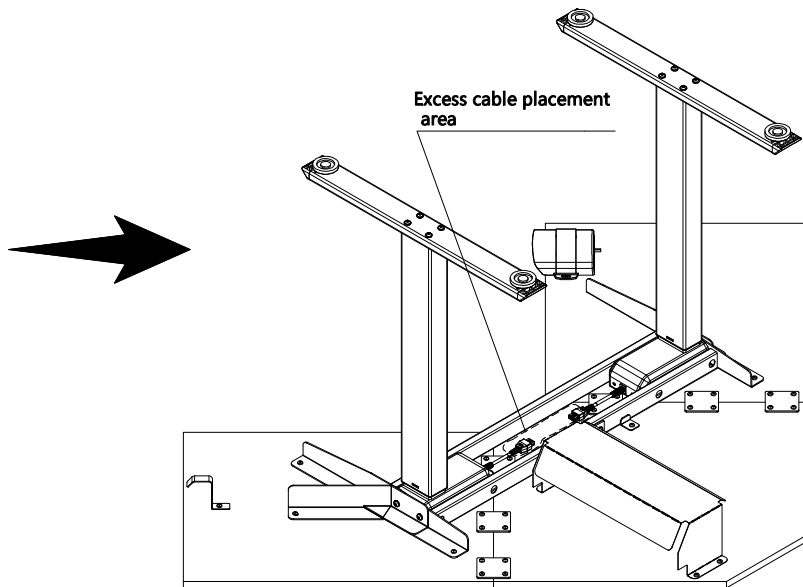

Step 10

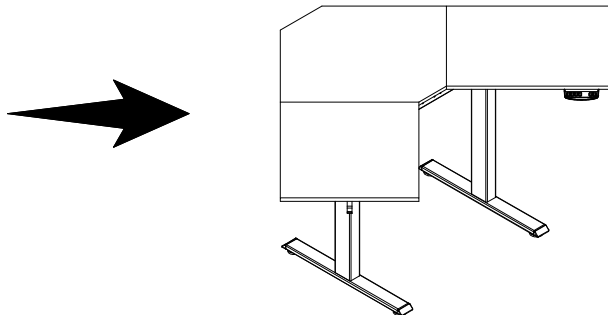
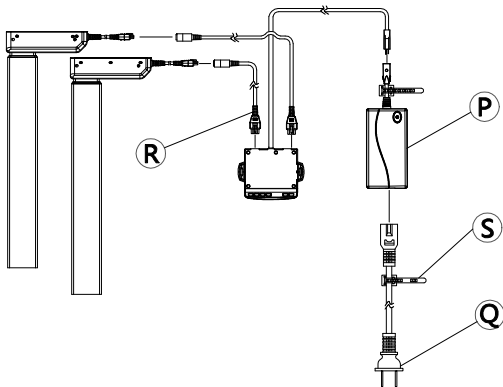

Checklist

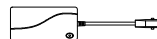

P - Power Supply

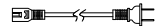

Q - Power Cord



R - Extension Cable x 2





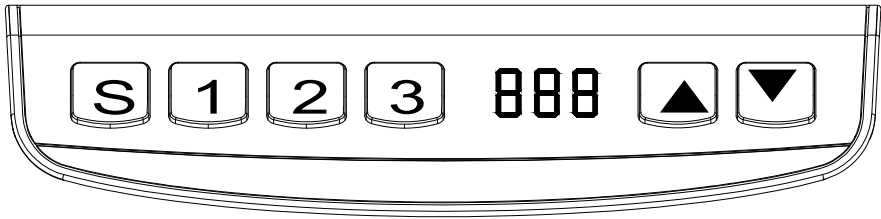

S - Cable clip x 8

Instruction





• Manual Reset

 It is necessary to be reset manually after the initial installation and power off.

-   • Keep pressing down key till the desktop till display shows "E-1" and "rES" alternately and release the key.
-  • Keep pressing down key, the desktop will move slowly down and return back till the display shows 27.6".
- Release the key , the height-adjustable desk resetting finished.





 Note: The anti-Collision function is not enabled during all resets. Please note that there is a potential risk of pinching in this case, and be sure no obstacles in the desk's path.

• Up and Down

-  • Keep pressing "up" key till the required height is reached.
-  • Keeping pressing "down" key till the required height is reached.

• Saving position

 Press the memory key until the columns have reached the desired memory position.

-   • Adjust the desktop to the height you want to save
-  • Press "S" key , till the display will show "S --"
-  • Press "1" , and the display will show alternately as "S-1" and the desktop height.
-  • Press "S" key, the first memory position is set successfully .Similar progress for 2 and 3 memory positions.









• Anti-Collision function

 Before use, please make sure removing obstacle in advance and human body is in the safe position.

-  • Once the desktop encounters any obstacle in its path, the screen displays "E-2".
• The desktop will move a defined distance in opposite direction, and it would be used normally after removing the obstacle.







● Container and self-stop positions

 Do not enable this function only when you are really need in some situation.









1.  • Keep pressing the key “S” for 3 seconds till the display shows “S--” to enter setup menu.
2.  • Press up key till the display flash as “HLP”.
3.   • Press “1”, the display show alternately as “H-P” and current height.
4.   • Keep pressing up or down key till the required upper limit position is reached.
5.  • Press “S”, the desktop height will be showed and the shelf stop position has been set.
6.   • Press “2”, the display will show alternately “L-P” and current height, keep pressing down key till the lower limit position is reached, press S, the container stop position has been set.

 Note: By this function would be used to limit the movement area of desktop, when the container is underneath or any shelf above the desktop. Once it is set, the new upper or lower limitation position will be stored.

● Change the displayed Unit(cm/inch)

1.  • Keep pressing key “S” till the display show “S--” to enter the setup menu.
2.   • Press “up” key, the display will show “Unt”.
3.  • Press “1” , and the display will show alternately as “Unt” and the desktop height unit by “cm”.
4.  • Press “S” key to save the unit as cm.
5.  • Press “2”, and the display will show alternately as “Unt” and the desktop height unit by “inch”,press key “S” to save the unit as inch.

● Amend the desktop height displayed

1.   • Keep pressing down key till the desktop till display shows “E-1” and “rES” alternately and release the key.
2.  • Keep pressing key “S” till the display show “A--” alternately.
3.   • Keep “Up” or “Dn” several times, till the display show “End” and height.(In this case, the unit is mm or inch when this system’s metric or imperial)
4.    • Press “1”, “2” and “3” respectively, and to adjust the first number, the second number and the third number. If you click one, the number will increase by 1, till you get to the value you want.

5. **S** • Press "S" the height has been changed to defined digit.

i Note: The function enables you to change the height shows on the display based on the actual measurement.

● Plug detection

i The function can detect whether the motors are collected normally.

1. **E-3** **rES** • Once the display shows "E-3" and "rES", it reminds you check whether any motors fail connected with control unit. Please connect the main cable again, wait at least 5 seconds.
2. • Connect all the plugs.
3. **rES** • Follow manual reset procedure.

● Reset to factory setting

i With this function, you can make the control unit to factory setting.

1. **S** • Keep pressing "S" till the display shows "FAC".
2. • Press "S", and the control unit to factory setting (including memory position, container-and shelf-stop position, etc).

Code meaning and Trouble shooting

【Code meaning】

| Code | Information | Operating |
|------|---|---|
| rES | Manual resetting | Refer to the progress of manual reset |
| ovr | Overloading | Remove the load on desktop till it less than 800N (175 LBS) for further operation |
| E-2 | Anti-Collision function | It can be used normally after removing the obstacle |
| dut | Operated continuously without suitable rest | Make the desk rest around 15minutes for further operation |

【Trouble shooting】

| Code | Operating |
|---|---|
| E-4 / The height between two legs exceed 1 inch | Stop the operation and reset, refer to Manual reset |
| E-3 | Check the cables and ensure they are well connected, and the height-adjustable desk can be used normally after manual reset |

Technical Data

【Technical Data】

| Item | Data |
|----------------|------------------------------|
| Input voltage | 100~240VAC |
| output voltage | 29VDC |
| Max loading | 800N |
| Height range | 27.6" ~ 47.3"/700mm ~ 1200mm |
| Duty cycle | 2 min on/ 18 min off |