

Assembly Instructions

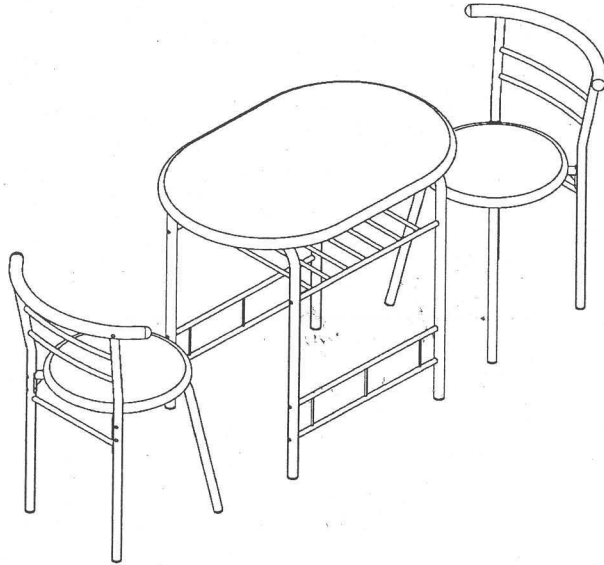

Thank you for purchasing our product!

Give us a chance to make it right.

Do not return this item. Contact our friendly customer service department with any problems or comments.

We appreciate your business!

Assembly Instruction

1

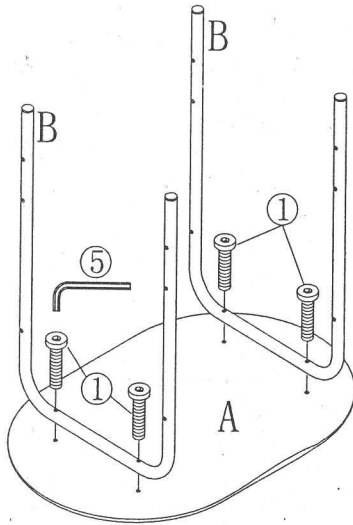

2

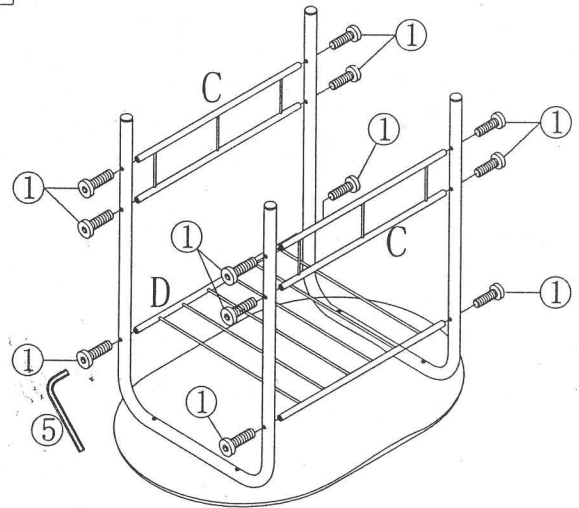

3

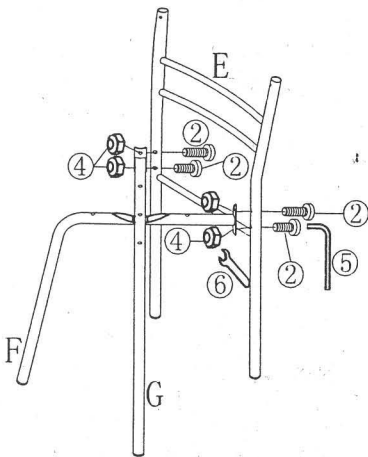



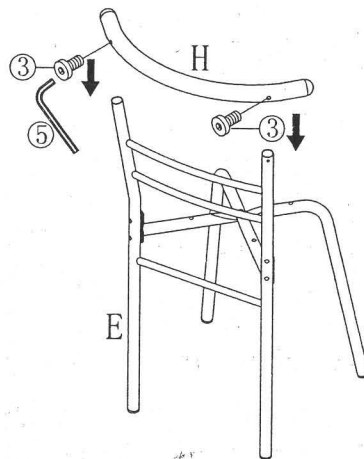



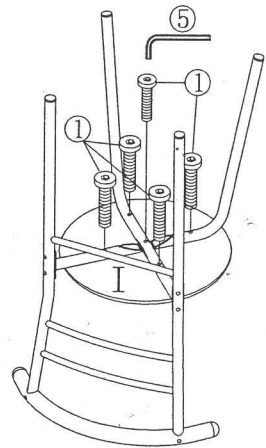



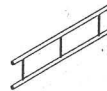



4

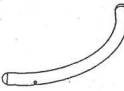

5



A TABLE TOP BOARD  1pc	B U SHARP TABLE LEG  2pcs	C APRON  2pcs	D LAYER SHELF  1pc	E CHAIR BACK  2pcs	1 BOLT  M6*32mm 26pcs	2 BOLT  M6*30mm 8pcs	3 BOLT  M6*12mm 4pcs
F LEFT CHAIR LEG  2pcs	G RIGHT CHAIR LEG  2pcs	H TOP CHAIR BACK  2pcs	I CHAIR SEAT  2pcs	4 NUT  M6 8pcs	5 TOOL  4mm 1pc	6 WRENCH  1pc	

IMPORTANT NOTES

1. Place all the parts on a clean and flat soft surface, such as carpet or rug to prevent from being scratched
2. Separate each type of part before beginning assembly the stool.
3. Do not tighten all bolts completely until after finish assembly. After few days, pls tighten all bolts again.