

READ AND SAVE THIS INSTRUCTIONS FOR FUTURE USE

# ASSEMBLY & INSTRUCTION MANUAL

**A1x 1**

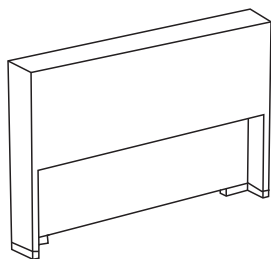

**B3x 1**

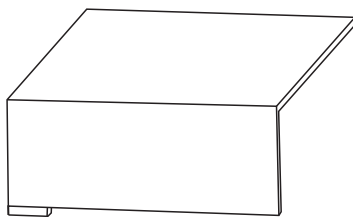

**F x 6**

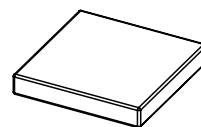

**A2x 1**

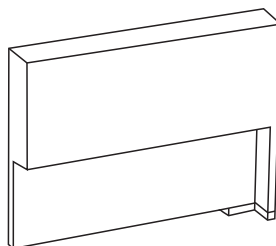

**C1x 4**

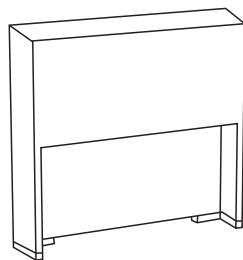

**G x 6**

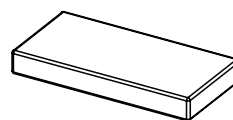

**A3x 1**

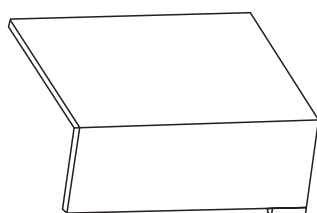

**C2x 4**

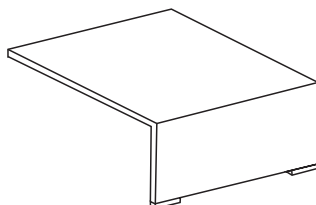

**H x 2**

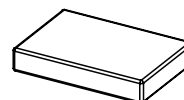

**C3x 4**



**I x 2**

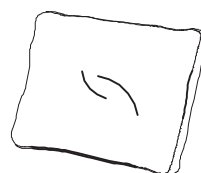

**B1x 1**

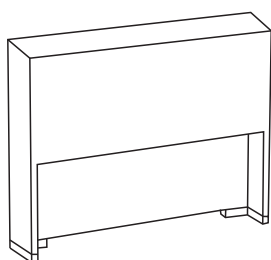

**D x 1**

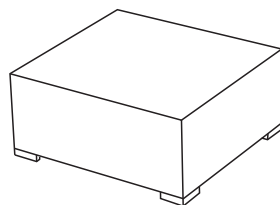

**J x50**



**B2x 1**

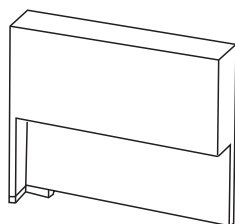

**E x 1**

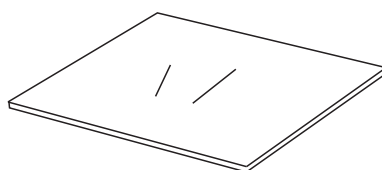

**K x50**



01

A1x 1

A2x 1

J x 2

K x 2

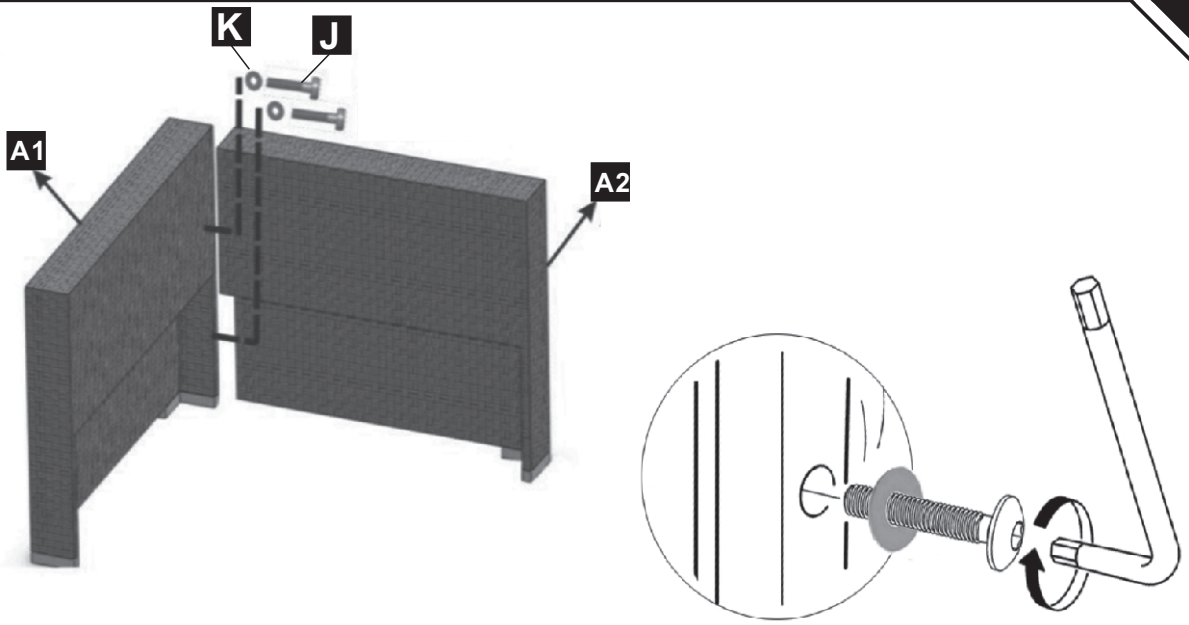

02

A3x 1

J x 7

K x 7

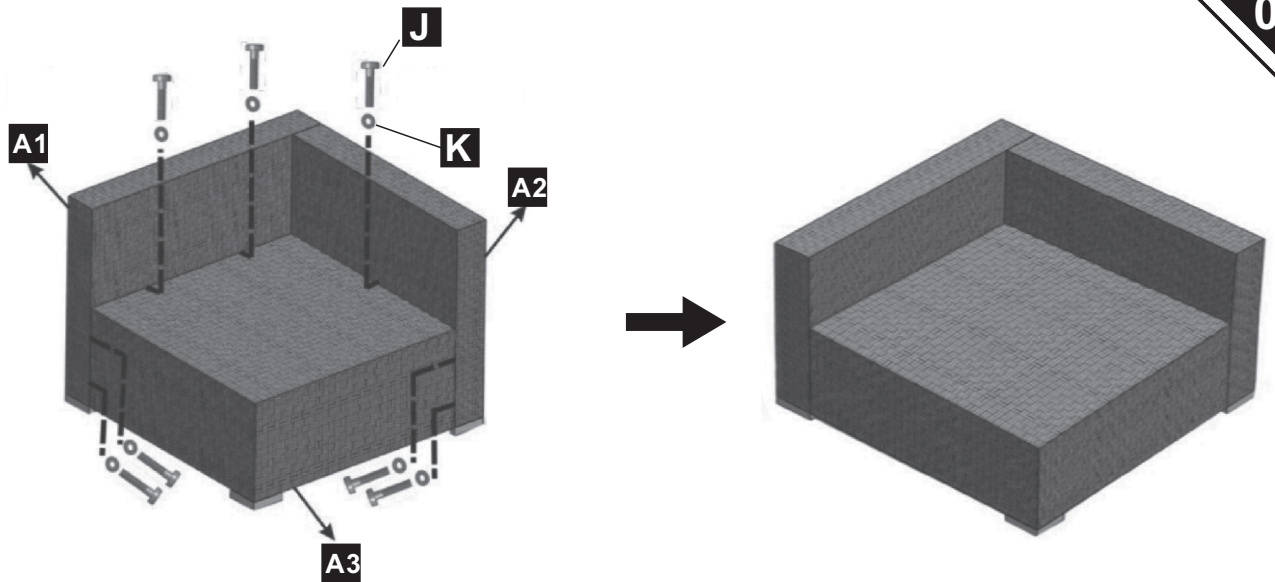

03

B1x 1

B2x 1

J x 2

K x 2

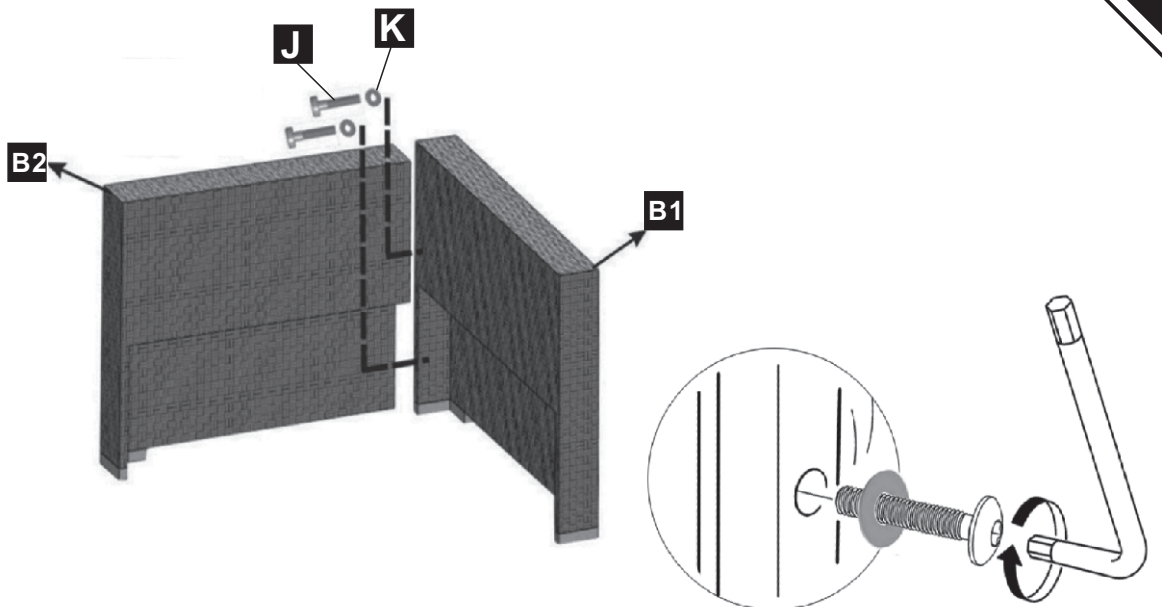

B3 x 1

J x 7

K x 7

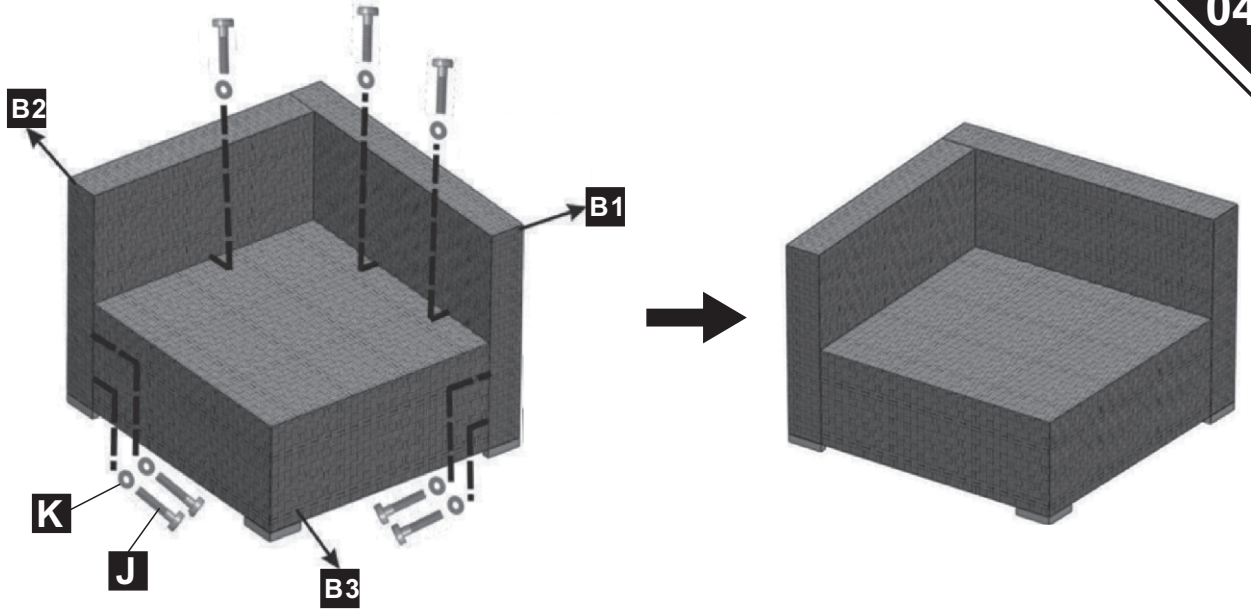

C1 x 1

C2 x 1

J x 4

K x 4

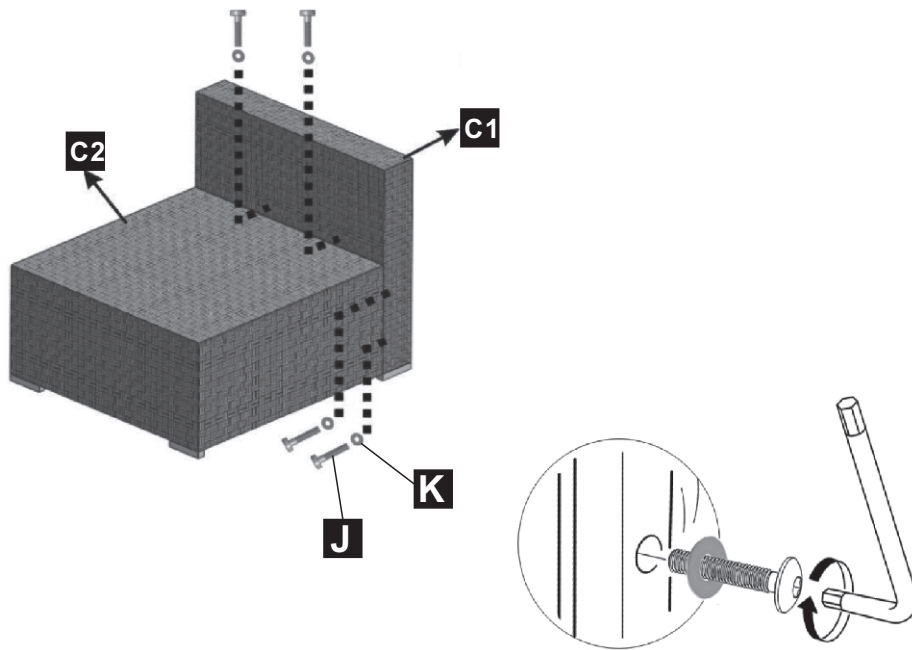

x4

C3 x 1

J x 4

K x 4

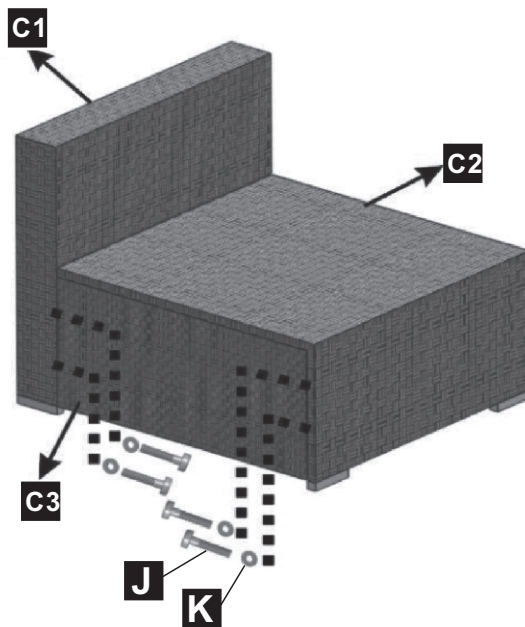

x4

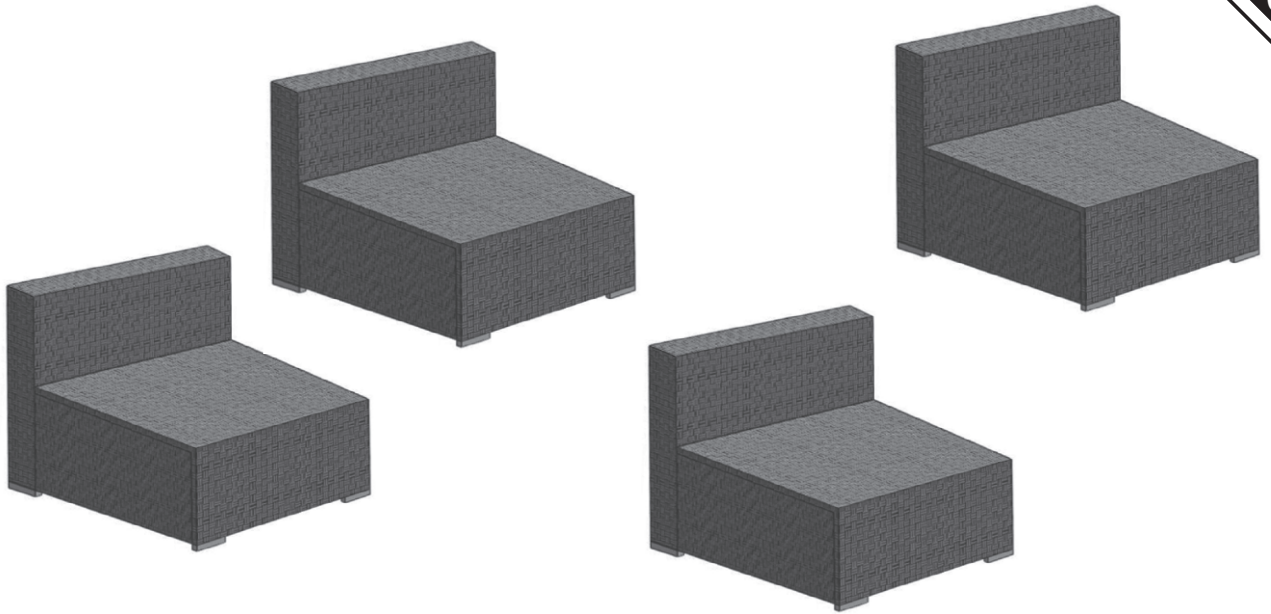

**D** x 1

**E** x 1

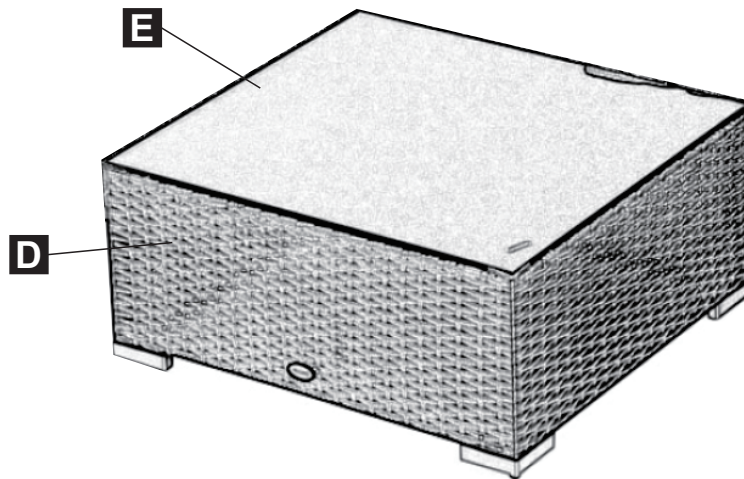

**F** x 6





**G** x 6

**H** x 2





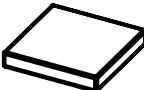

**I** x 2







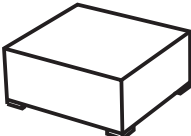

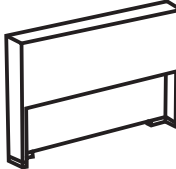
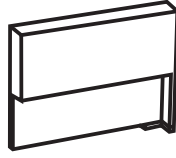

**BOX-1/3**

NO.	PARTS	QTY
C1		2
C2		2
C3		2
F		2
G		2
K + L		1

**BOX-2/3**

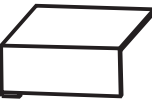
NO.	PARTS	QTY
C1		2
C2		2
C3		2
F		2
G		2
D		1
E		1

**BOX-3/3**

NO.	PARTS	QTY
A1		1
A2		1
A3		1
B1		1
B2		1
B3		1
F		2
G		2
H		2
I		2